

**Investigations on the
transfer of chemical
substances at the
water-sediment
interface in the Puck
Bay***

OCEANOLOGIA, No. 30
pp. 105-123, 1991.
PL ISSN 0078-3234

Sediment
Bottom water
Chamber experiments
Puck Bay

JERZY BOLAŁEK,
LUCYNA FALKOWSKA,
HALINA JANKOWSKA
Institute of Oceanography,
Gdańsk University,
Gdynia

ANDREY VERSHININ
Institute of Oceanology,
USSR Academy of Sciences,
Moscow

Manuscript received June 19, 1990, in final form April 19, 1991.

Abstract

The paper presents the investigations on the determination of the magnitude of fluxes of chemical substances exchanged between the bottom water and the sediment at two measuring stations of different sediment character. The investigations were carried out in June 1989 and comprised the observations of the changes of pH, as well as the concentration of oxygen, bicarbonates, nitrogen and phosphorus compounds, and dissolved silicates, in closed water systems. Two chambers were placed at each measuring station, one of them isolated from the bottom. Water samples were drawn from the chambers and their vicinity once a day for 15 days.

Reducing conditions formed in the chambers contacting the sediment favoured the liberation of phosphorus, ammonia and silicates from the sediment to water. The oxygen consumption by the sediment was $78.7 \text{ mmole} \cdot \text{m}^{-2} \cdot \text{day}^{-1}$ at the first station and $46.1 \text{ mmole} \cdot \text{m}^{-2} \cdot \text{day}^{-1}$ at the second station. The fluxes of the liberated phosphates, ammonia and silicates were 0.8, 0.2 and $1.7 \text{ mmole} \cdot \text{m}^{-2} \cdot \text{day}^{-1}$

* The investigations were carried out under the research programme CPBP 03.03.C, co-ordinated by the Institute of Oceanology of the Polish Academy of Sciences.

at the second station. The character of the sediment exerted the greatest influence on the amount of the liberated phosphate phosphorus.

1. Introduction

Exchange processes taking place at the sea water-bottom sediment interface play an important role in the creation of the chemical composition of the bottom layers of sea water, as well as the near surface layer of sediments and interstitial water. Mutual interaction of these environments result in a creation of fluxes of chemical substances directed from the sediment to the water or *vice versa* (Hall, 1984). Certain biological processes play a significant role in this exchange, which is manifested by bacterial mechanism of numerous diagenetic transformations in the sediment, related to the decomposition of the organic matter and to changes in the sediment physico-chemical properties due to bioturbations (Berner, 1971).

The magnitude of the transport of chemical substances from the sediment to water or *vice versa* depends on the following factors: intensity of biochemical reactions in the surface layer of the sediment, intensity of the processes of mechanical transport of chemical substances between the sea water and the interstitial water, and the magnitude of molecular diffusion.

The following methods are used in the investigations on the transport of chemical substances at the water-sediment interface:

- balance of chemical substances circulation in the marine environment (Sayles, 1979),
- modeling of diffusion-diagenetic processes based on chemical analysis of the interstitial water and the sediments (Berner, 1971; Lerman, 1978; Sayles, 1979),
- the *in situ* investigations on the chemical exchange (Balzer, 1982; Bågander, 1977; Hall, 1984; Holm, 1978; Rozanov *et al.*, 1988).

In the Polish zone of the Baltic the problems of the chemical exchange between the sea water and the bottom sediments have not been separately studied so far. The experiment performed in the Puck Bay and described in this paper constitutes an introduction to this problem.

The investigations aimed at examining the method of direct measurements of the chemical exchange at the water-sediment interface in the Puck Bay and at initial evaluation of the intensity of this exchange.

2. Materials and methods

In June, 1989, the employees of the Institute of Oceanography of the Gdańsk University and of the Institute of Oceanology of the Academy of Sciences in Moscow performed in the Puck Bay the investigations on the

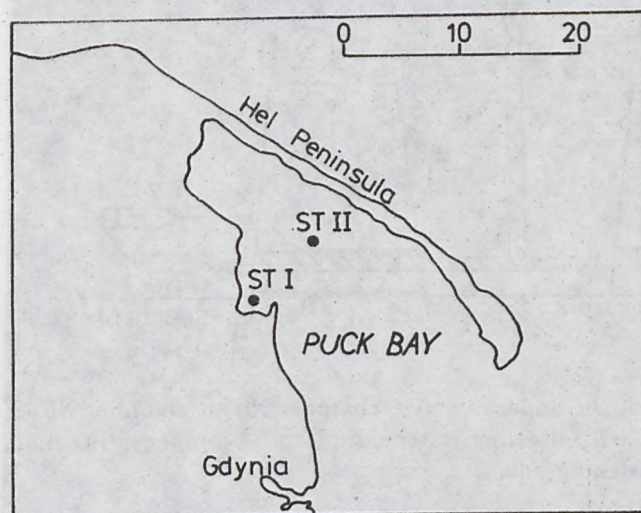

Fig. 1. Location of measuring stations

transport of chemical substances between water and the bottom sediment using the *in situ* method. The investigations were carried out at two measuring stations located at a depth of 4 m (Station I – ST I) and 8 m (Station II – ST II) (Fig. 1). The measurements were performed over 15 days, from 7th to 21st June.

2.1. Description of the apparatus

The apparatus consisted of two cylindrical chambers fixed on a common frame, enabling the placement of the apparatus at the bottom (Fig. 2). The volume of each of the chambers was 40.89 dm^3 , the height 0.47 m, while the cross section area of placement was 0.087 m^2 . Stirrers were mounted in the upper part of the chambers in order to transfer the motions of the near bottom water to water closed in the chamber and to enable the homogenization of the water each time before sampling. Two plugged holes were situated on the lateral walls of the chambers – one serving for drawing the water samples, while the other enabling the compensating inflow of the surrounding water to the chamber. The apparatus was made of materials of high chemical resistance, like polyethylene, PTFE and rubber. The apparatus was the property of the Institute of Oceanology of the USSR Academy of Sciences in Moscow.

2.2. Placement of the instruments at the measuring stations

Lithological character of the bottom of the basin and the depth constituted the main criteria in the choice of the measuring stations.

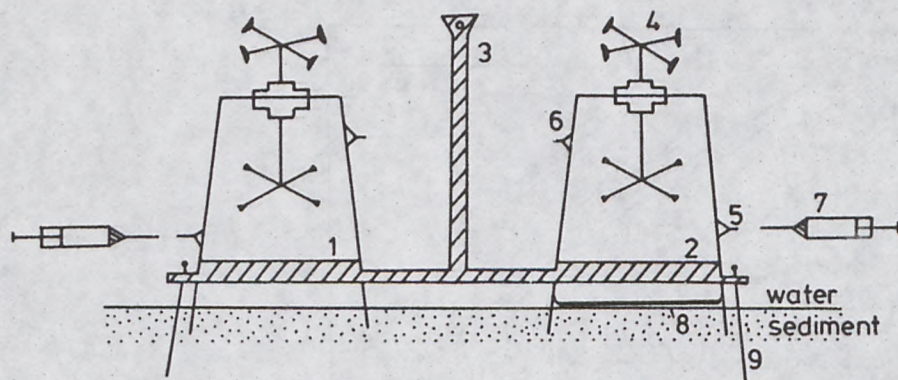

Fig. 2. Schematic diagram of the apparatus: 1 - chamber No. 1, chamber No. 2, 3 - frame, 4 - stirrer, 5 - hole for drawing water samples, 6 - compensating hole, 7 - syringe, 8 - cover, 9 - fastening bolt

The first station (ST I) - shallow, coastal region of the Bay (4 m depth) on fine-grained sandy sediments covered by a series of organogenic matter.

The second station (ST II) - deeper part of the basin (8 m depth) on medium-grained sandy sediments (Fig. 1).

The possible submarine inflow of underground water in the region (Jankowska and Bolalek, 1990) was taken into account when choosing the location of ST I.

Before the placement of the apparatus at the measuring stations the chambers were covered with black covers (in order to eliminate photosynthesis) and marked with numbers 1 and 2. Then the apparatus was placed at the bottom by scuba divers. Prior to the placement at the bottom the chambers were thoroughly rinsed with the near bottom water and settled in such a way that their lower edge penetrated the sediment to a depth of 15 cm.

In chamber No. 1 the near bottom water was in direct contact with the sediment, while in chamber No. 2 the water was isolated from the sediment with a cover tightly adhering to the chamber.

2.3. Methods of measurements

The following samples were drawn during the investigations:

1. Bottom sediment cores. Core samples were drawn twice. The first series was drawn directly after the placement of the chambers, while the second - after finishing the investigations, from below the No. 1 chamber. The cores were drawn by scuba divers, using the 'Kajak' type probes of 0.5 m length and 4 cm diameter. The investigations were performed on 5 cm segments of the core. The following have been determined in the samples:

- lithology – on the basis of granulometric analysis of the sediment,
 - humidity – by drying at 100°C,
 - organic matter content – by mineralization at 550°C,
 - pH – using the N 517 type pH-meter with an SAgP-209W electrode,
 - Eh – using a PtP-201 platinum electrode and an AgClP-211T silver/silver chloride electrode.
2. Water from the chambers and from the vicinity of the measuring station. Water samples were drawn by the scuba divers with 600 cc syringes from the two chambers at both the stations. A sample of the near-bottom water from the vicinity of the station was simultaneously drawn. During sampling the compensating hole, enabling the inflow of water to the chamber, was opened. Water samples were drawn once a day at the same time (ST I – between 10.00 and 12.00, ST II – between 13.00 and 14.00).

Sea water and bottom sediment samples were analyzed in land laboratory two hours after sampling. The following have been determined: dissolved oxygen, hydrogen sulphide, pH, Eh, macrocomponents (Cl^- , HCO_3^- , Ca^{+2} , Mg^{+2}), nitrogen and phosphorus compounds, and silicates. The chemical composition of the sea water was analysed by methods used in sea chemistry (Grasshoff, 1976; Shishkina, 1972; Valderrama, 1981).

The phyto- and zooplankton composition in the near-bottom water has been determined for each measuring station by methods recommended by BMB (Edler, 1979).

The near-bottom water temperature was measured at both the stations. It varied slightly during the entire measuring period and was equal on average to 12.5°C and 8.5°C at ST I and ST II, respectively.

2.4. Methods of calculation of chemical substance fluxes between the sediment and water

The chemical substance flux between the sediment and the near-bottom water can be described by the following dependence (Hall, 1984):

$$J = -H \frac{dC}{dT} \quad (1)$$

In a linear approximation:

$$J = -H \frac{\Delta C}{\Delta t} = -H \frac{(C_{k1} - C_{p1}) - (C_{k2} - C_{p2})}{\Delta t}, \quad (2)$$

where:

J – dissolved compound flux from the water to the sediment or *vice versa* [$\text{mmole} \cdot \text{m}^{-2} \cdot \text{day}^{-1}$],

- H – chamber height [m],
 t – time [days],
 $\frac{\Delta C}{\Delta t}$ – change in the concentration of the given substance in the dissolved form due to the exchange between the sediment and the water [mmole · dm⁻³],
 C_{p1} – initial concentration of the dissolved chemical substance in chamber No. 1 [mmole · dm⁻³],
 C_{k1} – final concentration of the dissolved chemical substance in chamber No. 1 [mmole · dm⁻³],
 C_{p2}, C_{k2} – initial and final concentration of the dissolved chemical substance in chamber No. 2 [mmole · dm⁻³].

The $C_{k2} - C_{p2}$ term denotes the changes taking place solely in the near-bottom water. The $C_{k1} - C_{p1}$ concentration difference describes concentration variability in the near-bottom water due to the sediment-water interaction. The $(C_{k1} - C_{p1}) - (C_{k2} - C_{p2})$ term denotes the concentration change due to the transfer of substances at the water-sediment interface. It can be assumed that $C_{p1} = C_{p2}$, since water of the same chemical composition was closed in the chambers. In such a case the final formula describing the magnitude of the flux J has the form:

$$J = -H \frac{C_{k1} - C_{k2}}{\Delta t}. \quad (3)$$

In the case of oxygen the consumption fluxes were calculated assuming Δt equal 1 day; for hydrogen sulphide it was 3 days, while for the remaining components Δt was equal to the length of the measuring period. The accuracy of the linear approximation is better, the shorter the time between subsequent concentration measurements. However, the manner of calculations adopted in this paper seems to be sufficient for the initial estimation of the fluxes of substances exchanged in both directions at the sediment-water interface and for a comparison with literature data.

3. Results and discussion

3.1. Bottom sediment characteristics

Bottom sediments from the region of Station I are formed by coastal sedimentation. Sandy and organic sediments occurred in the surface layer in this case. In the vertical profile, fine and very fine sands (according to the classification by Wentworth, 1922) occurred down to the depth of 15 cm. Their humidity varied from 27% to 42%, while the organic matter content ranged from 1.86% to 6.64% (Fig. 3). They were the quartz-feldspar sands, containing 82.3% quartz, 8.3% alkaine feldspar and 5.7% plagioclases. A 5 cm layer of organic alluvial deposits (according to the classification by Pieczka) occurred below the sands. Their humidity was 63%, while

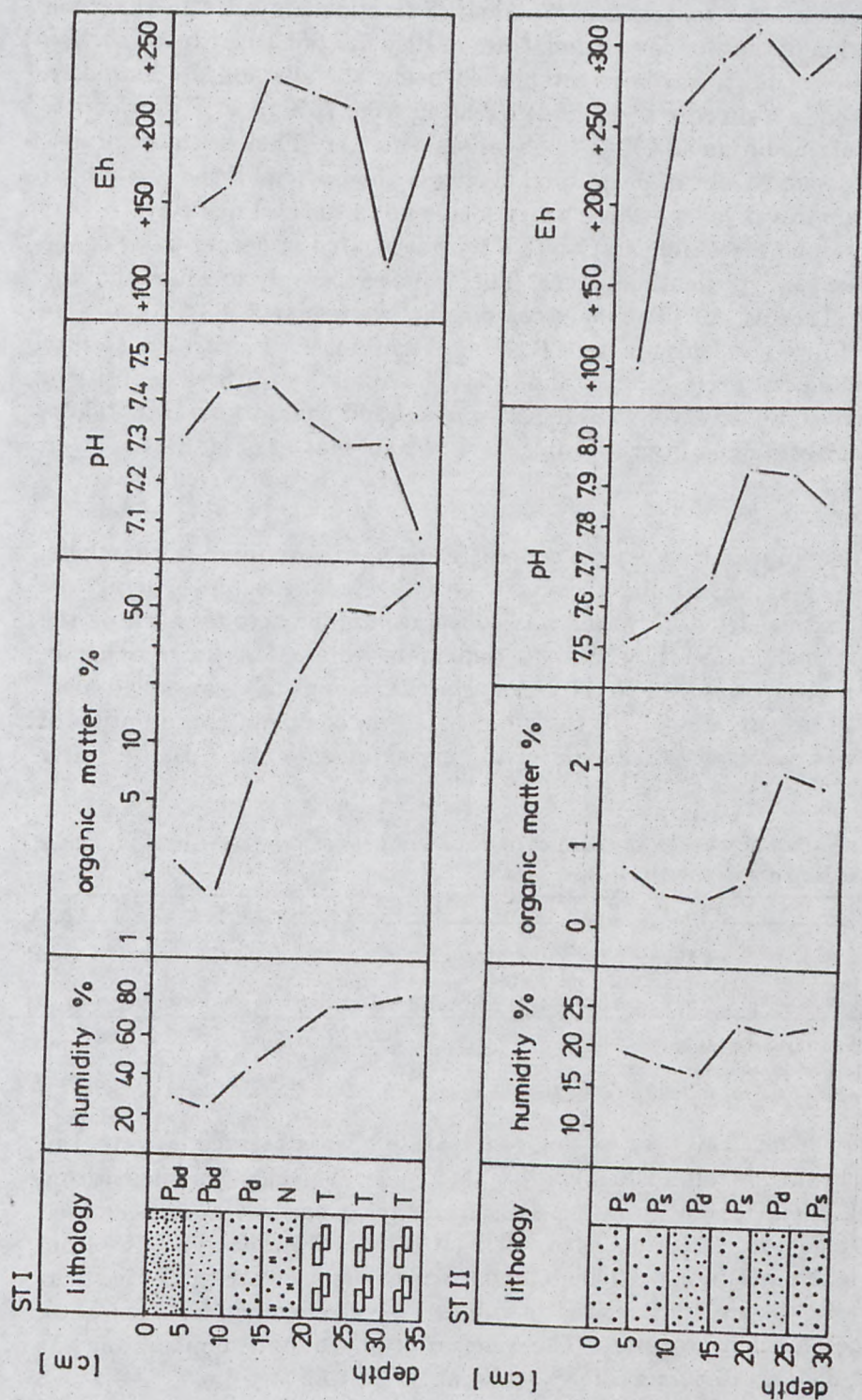

Fig. 3. Characteristics of bottom sediments. P_{bd} - very fine sand, P_d - fine sand, P_s - medium sand, N - organic alluvion, T - peat

the organic matter content 22.7%. Aleurite fraction prevailed in the grain composition of the alluvion. Admixtures of silty fraction constituted *ca.* 8%. Occurrence of peats has been established below the alluvion, its humidity, determined in 5 cm core segments, increasing from 76% to 84% with depth. Peats contained from 48.7% to 70.8% organic matter. They are most probably the fossil outcrops of peats spreading over the bottom of the Kashubian proglacial stream valley, whose western side flows to the Puck Bay.

The second measuring station (ST II) was located in deeper parts of the bay, where sandy formations occur. They were exclusively medium and fine sands, well sorted out. The main components were quartz (83.3%), alkaine feldspar (5.7%) and plagioclases (2.7%). Admixtures of aleurite and silty fractions did not exceed the total of 3%. The humidity of these deposits in the examined 30 cm layer was almost constant and equal to *ca.* 20%. These formations contained from 0.43 to 1.97% organic matter (Fig. 3).

3.2. Oxygen

Changes in dissolved oxygen concentration were very rapid in chambers, in which water was in direct contact with the sediment. In general, the oxygen contained in the water was consumed in the second week of the investigations. At ST I, where the sediments were a few times richer in organic matter compared to ST II, oxygen was completely consumed after 12 days of investigations. On the other hand, no complete consumption of oxygen was observed till the end of the measurements at ST II, *i.e.* after 15 days.

Table 1. Fluxes of transfer of chemical substances between the near-bottom water and the sediments in the Puck Bay

Compounds	PO ₄ -P	P _{org}	P _{tot}	NH ₄ -N	SiO ₃ -Si	H ₂ S*	O ₂ **	HCO ₃ ⁻
Station I								
[mmole · m ⁻² · day ⁻¹]	0.78†	0.10†	0.87†	0.19†	1.72†	0.77†	78.72‡	53.65†
Station II								
[mmole · m ⁻² · day ⁻¹]	0.21†	0.08†	0.21†	0.29†	2.10†		46.08‡	7.74†

* - based on three determinations,

** - for the first measurement day,

† - the sense of the arrow indicates the flow direction.

A slow reduction of the oxygen concentration was observed in water isolated from the bottom (chambers No. 2) (Fig. 4). The changes ranged from 0.08 to 1.32 ml O₂ · dm⁻³ · day⁻¹. Dissolved oxygen concentration decreased during 15 days at ST I from 7.46 to 2.39 ml O₂ · dm⁻³, while at ST II - from 7.73 to 5.57 ml O₂ · dm⁻³. The different rate of the decrease at the particular stations was probably related to different oxygen demand for respiration and mineralization processes. The biomass of phyto- and zooplankton was equal at ST I to 16.80 mg · dm⁻³, while at ST II 1.52 mg · dm⁻³.

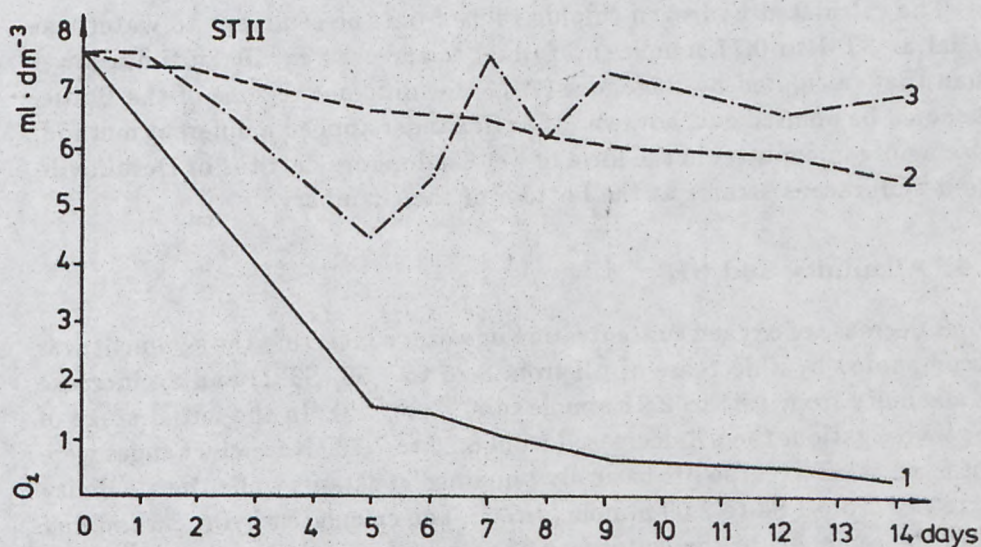
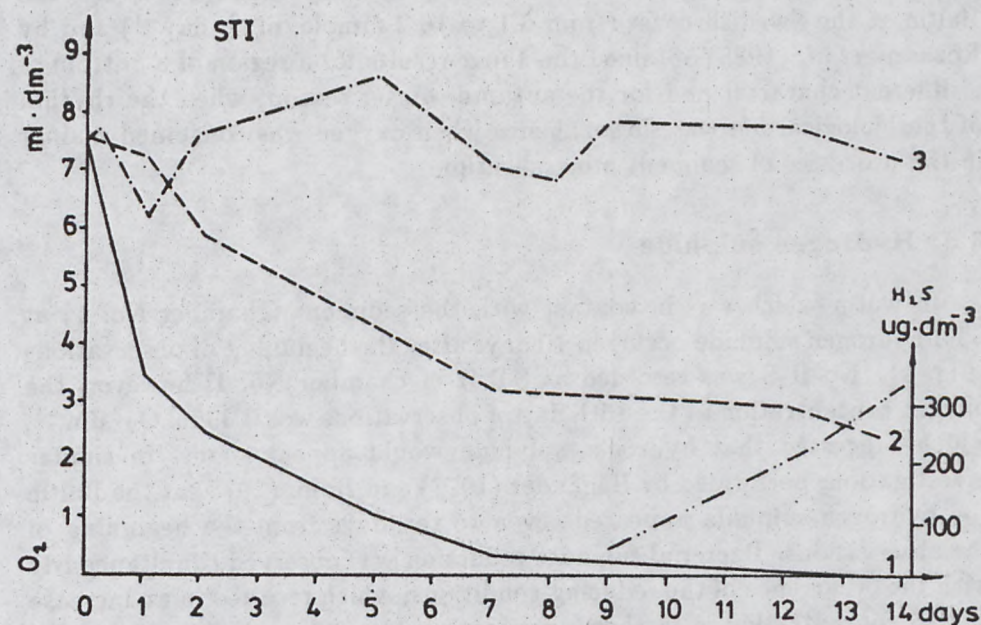

Fig. 4. Changes in dissolved oxygen concentration. 1 - chamber No. 1, 2 - chamber No. 2, 3 - near-bottom water

The calculated fluxes of oxygen consumed by the sediment at the initial stage of the observations (first day) are equal to 78.7 and 46.08 $\text{mmole} \cdot \text{m}^{-2} \cdot \text{day}^{-1}$ at ST I and ST II, respectively (Tabl. 1). These

values are slightly higher than those reported by Hall (1984) for the Baltic at the Swedish coast (from 6.1 to 16.2 mmole · m⁻² · day⁻¹) and by Rozanov *et al.* (1988) obtained the above results for a region of a bottom of a different character and for the autumn–winter season, when the rhythm of the biological life was slower, hence when oxygen was consumed mainly in the processes of sediment mineralization.

3.3. Hydrogen sulphide

In water which was in contact with the sediment (chamber No. 1) at ST I hydrogen sulphide occurred 10 days after the beginning of observations (Fig. 4). No H₂S was recorded at ST II in chamber No. 1; however, the oxygen concentration at the 15th day of observations was 0.33 ml O₂ · dm⁻³, which suggested that hydrogen sulphide would appear soon. In similar investigations performed by Bågander (1977) and Holm (1978) at the Baltic the hydrogen sulphide appeared seven to ten days from the beginning of the observations. Bacterial sulphate reduction was observed simultaneously with the occurrence of the reducing conditions, which resulted in an increase in H₂S concentration in further investigations.

The calculated hydrogen sulphide flux from the sediment to water was equal at ST I to 0.77 mmole · m⁻² · day⁻¹, and was *ca.* 10–20 times lower than that calculated by Bågander (1977) for different regions of the Baltic. It should be pointed out, however, that Bågander applied a different method, placing organic matter in the form of wet *Cladophora* detritus or *Desulfovibrio desulfuricans* strains at the bottom of the chambers.

3.4. Alkalinity and pH

A decrease of oxygen concentration in water contacting the sediment was accompanied by a decrease of pH from 8.26 to 7.58 (ST I) and an increase in alkalinity from 1.84 to 2.91 mmole · dm⁻³ (Fig. 5). In the initial stage of the investigations the pH decreased from 8.26 to 7.70. No such changes were observed at ST II – the pH basically remained constant, while the alkalinity increased from 1.84 to 2.09 mmole · dm⁻³. The calculated hydrocarbon flux from the sediment to the water was 33.65 mmole · m⁻² · day⁻¹ at ST I and 7.74 mmole · m⁻² · day⁻¹ at ST II. The alkalinity change in the sediment is due to diagenetic processes taking place in this medium and is related to sulphate reduction and organic matter oxidation according to the following equation (Shishkina, 1972):

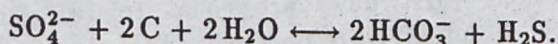

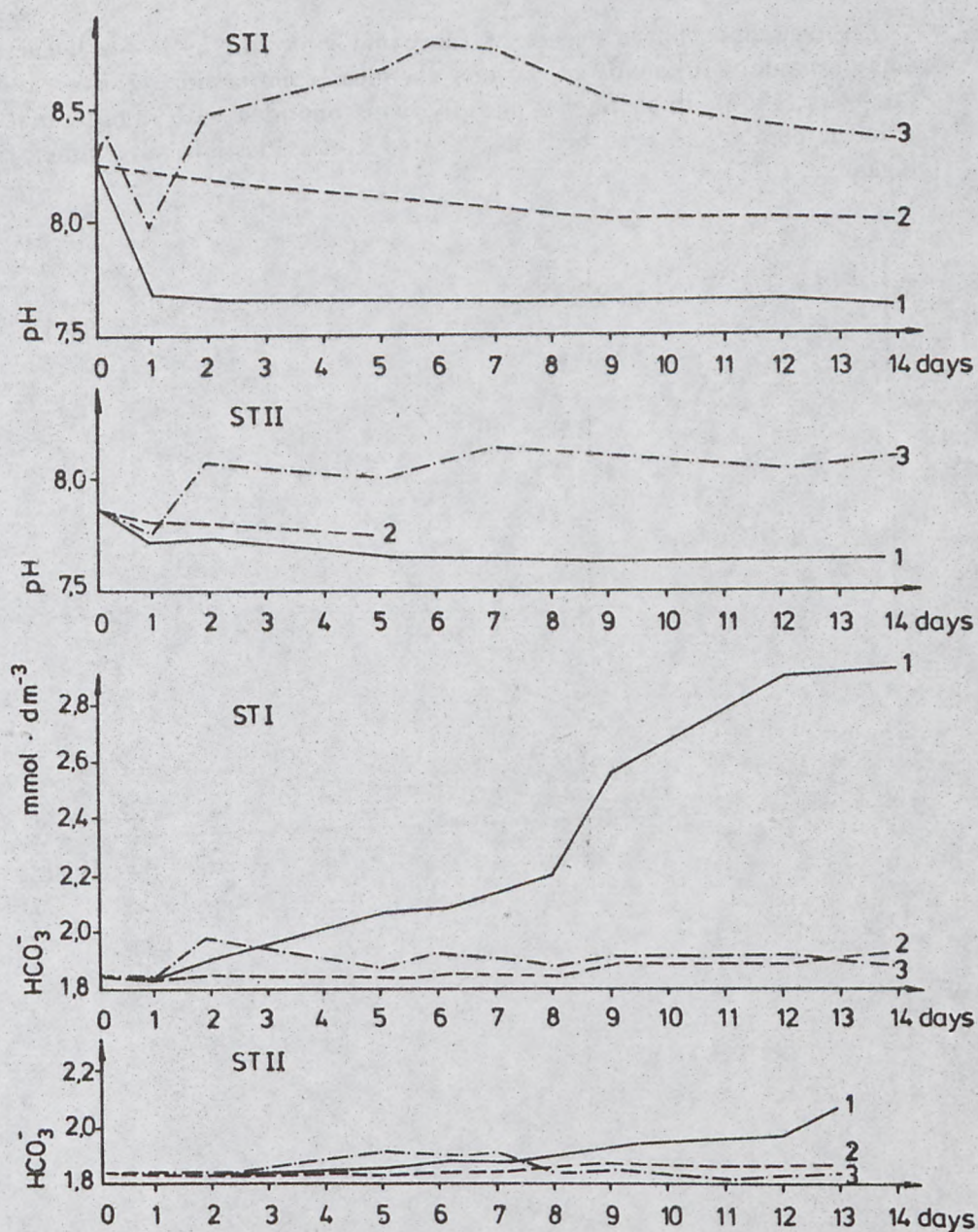

Fig. 5. Changes in pH and alkalinity. 1, 2, 3 - as in Figure 4

Different magnitudes of HCO_3^- fluxes at the two stations are probably related to the amount of organic matter in the bottom sediments (more than 3 times higher at ST I than at ST II).

3.5. Phosphorus

Dissolved phosphorus occurs as inorganic ions and as low-molecular weight organic compounds of various chemical composition (Kester and Pytkiewicz, 1967). In sediments phosphorus is bounded with organic matter and minerals, and adsorbed on hydrated iron oxides and silty minerals (Bågander, 1977).

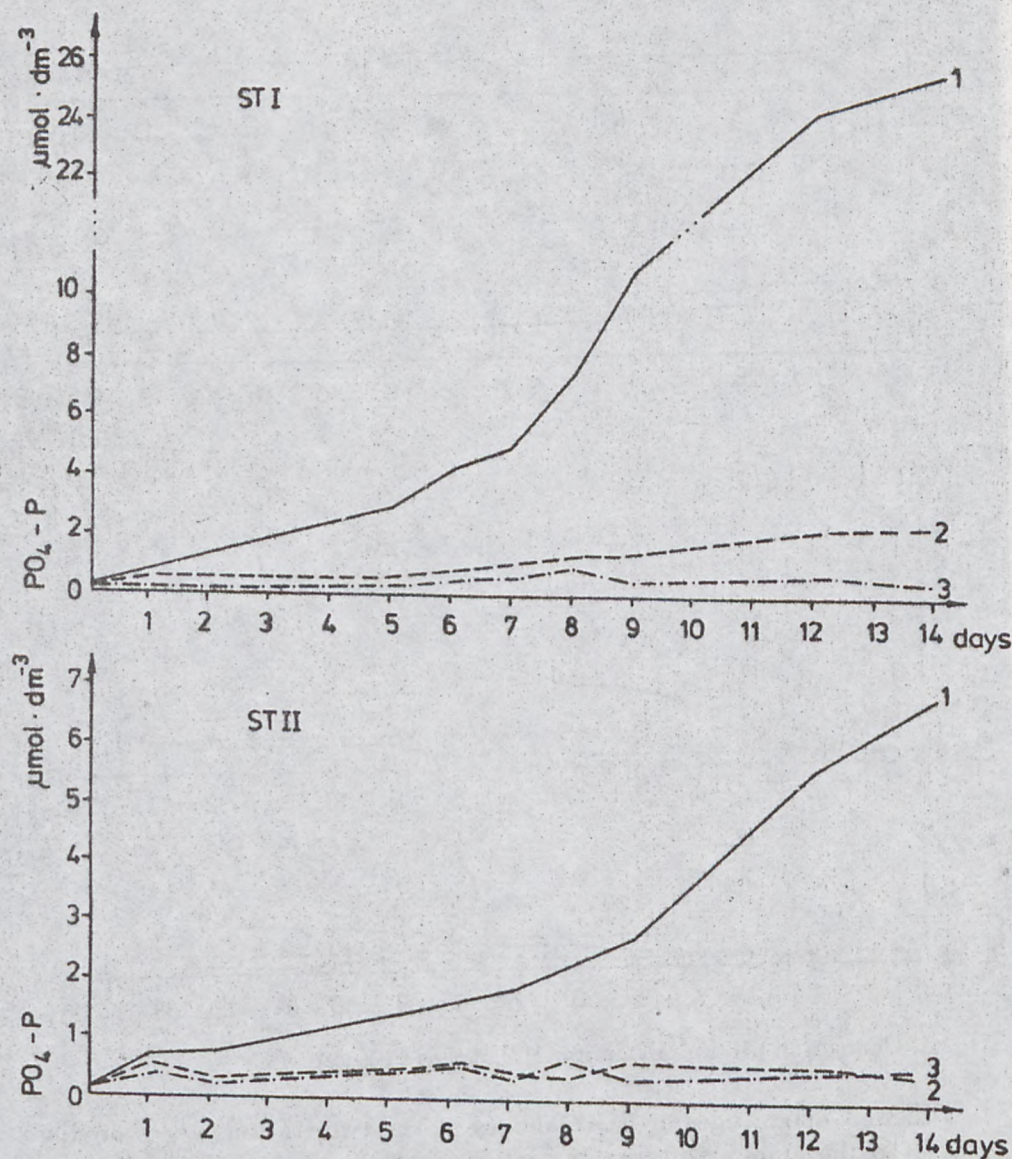

Fig. 6. Changes in phosphate concentration. 1, 2, 3 - as in Figure 4

In water isolated from the bottom the changes in phosphate concentration were small and comparable with the changes in the adjacent water (Fig. 6).

A slight increase in phosphate concentration in the chambers, where water was in contact with the bottom, started on the first days of the observations mainly as a result of photosynthesis inhibition. A more pronounced phosphate concentration increase was observed beginning from the 7th day of observations, when oxygen concentration from 0.25 to 28.96 $\mu\text{mole} \cdot \text{dm}^{-3}$ and from 0.25 to 7.06 $\mu\text{mole} \cdot \text{dm}^{-3}$ was observed at ST I and ST II, respectively.

On the day of the beginning of the observations the concentration of organic phosphorus in the near bottom water was *ca.* 0.3 $\mu\text{mole} \cdot \text{dm}^{-3}$ at ST I and *ca.* 0.2 $\mu\text{mole} \cdot \text{dm}^{-3}$ at ST II. At both the stations it remained almost constant in chamber No. 2 during the observations an almost ten-fold increase in organic phosphorus concentration in chamber No. 1 was observed at ST I, and a circa two-fold at ST II. The different magnitude of organic phosphorus concentration increase in the water is probably due to the different organic matter content of the bottom sediments (Fig. 3). Holm's (1978) investigations on the liberation of phosphates in relation to the amount of the organic matter added to the chambers proved that the liberation of phosphates per unit area is directly proportional to the added amount of

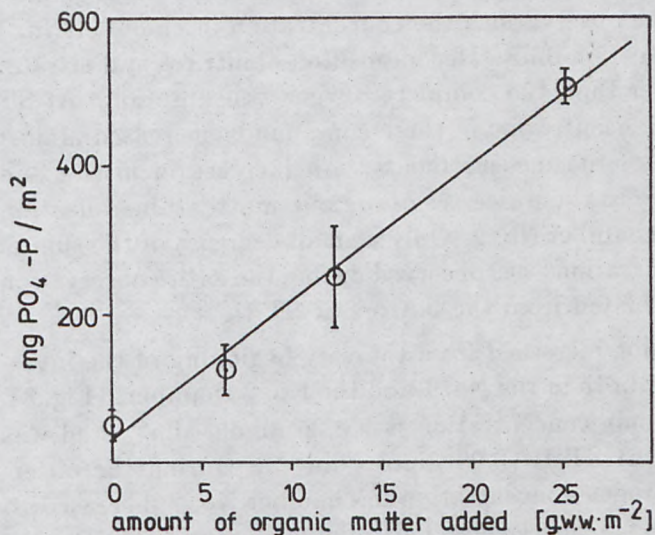

Fig. 7. The amount of liberated phosphorus vs. the amount of the organic matter added

the organic matter (Fig. 7). It can be anticipated, therefore, that the magnitude of the phosphate flux from the sediment to sea water in the Puck Bay (Tabl. 1) is also dependent on the amount of the organic matter in the sediments. This is shown by the value of the calculated flux of phosphates liberated from the sediment at ST I, being 3.7 times higher than at ST II, while the organic matter content in the sediment was 3.6 times higher at ST I than at ST II. In the case of the organic phosphorus its flux depends probably not only on the amount, but also on the quality of the organic matter deposited at the bottom.

The phosphate phosphorus flux liberated from the sediment to water at ST I was $24.2 \text{ mg} \cdot \text{m}^{-2} \cdot \text{day}^{-1}$, and at ST II $6.5 \text{ mg} \cdot \text{m}^{-2} \cdot \text{day}^{-1}$ phosphate flux calculated for the Bornholm Basin was close to the results obtained for the Puck Bay and was $18 \text{ mg} \cdot \text{m}^{-2} \cdot \text{day}^{-1}$ (Holm, 1978). According to Holm, the value of $30\text{--}40 \text{ mg} \cdot \text{m}^{-2} \cdot \text{day}^{-1}$ increasing with depth is probable for the Baltic.

3.6. Nitrogen compounds

Organic matter is the main source of nitrogen in the sediments. Under reducing conditions nitrogen is liberated in the form of ammonia (Bågander, 1977).

At the beginning of the experiment the sum of nitrites and nitrates in sea water at both the stations was slightly below $1 \mu\text{mole} \cdot \text{dm}^{-3}$. Beginning from the tenth day of the observations the concentration in chamber No. 1 at ST I fell below the detection limit. Decomposition of nitrites and nitrates took place slightly sooner than the complete oxygen consumption. At ST II in chamber No. 1 the concentration of these compounds decreased almost to zero on the last day of the measurements. An increase in nitrite and nitrate concentration due to the processes of organic matter mineralization was observed at ST I in chamber No. 2. Only a small decrease of the sum of nitrite and nitrate concentrations was observed during the entire observation period in the chamber isolated from the bottom at ST II.

Ammonia concentration increased from the very beginning of the investigations in the Puck Bay both in the No. 1 and the No. 2 chambers (Fig. 8). At ST I the initial ammonia concentration was $0.26 \mu\text{mole} \cdot \text{dm}^{-3}$ and was a few times higher than at ST II ($0.04 \mu\text{mole} \cdot \text{dm}^{-3}$). During the observations the ammonia nitrogen concentration in chamber No. 2 increased to 4.88 and $1.16 \mu\text{mole} \cdot \text{dm}^{-3}$, respectively. The differences may be due to different amounts of phyto- and zooplankton undergoing mineralization. The estimated ammonia flux from the sediment to water was slightly higher at ST II (Tabl. 1), although the sediments at ST II were poorer in organic

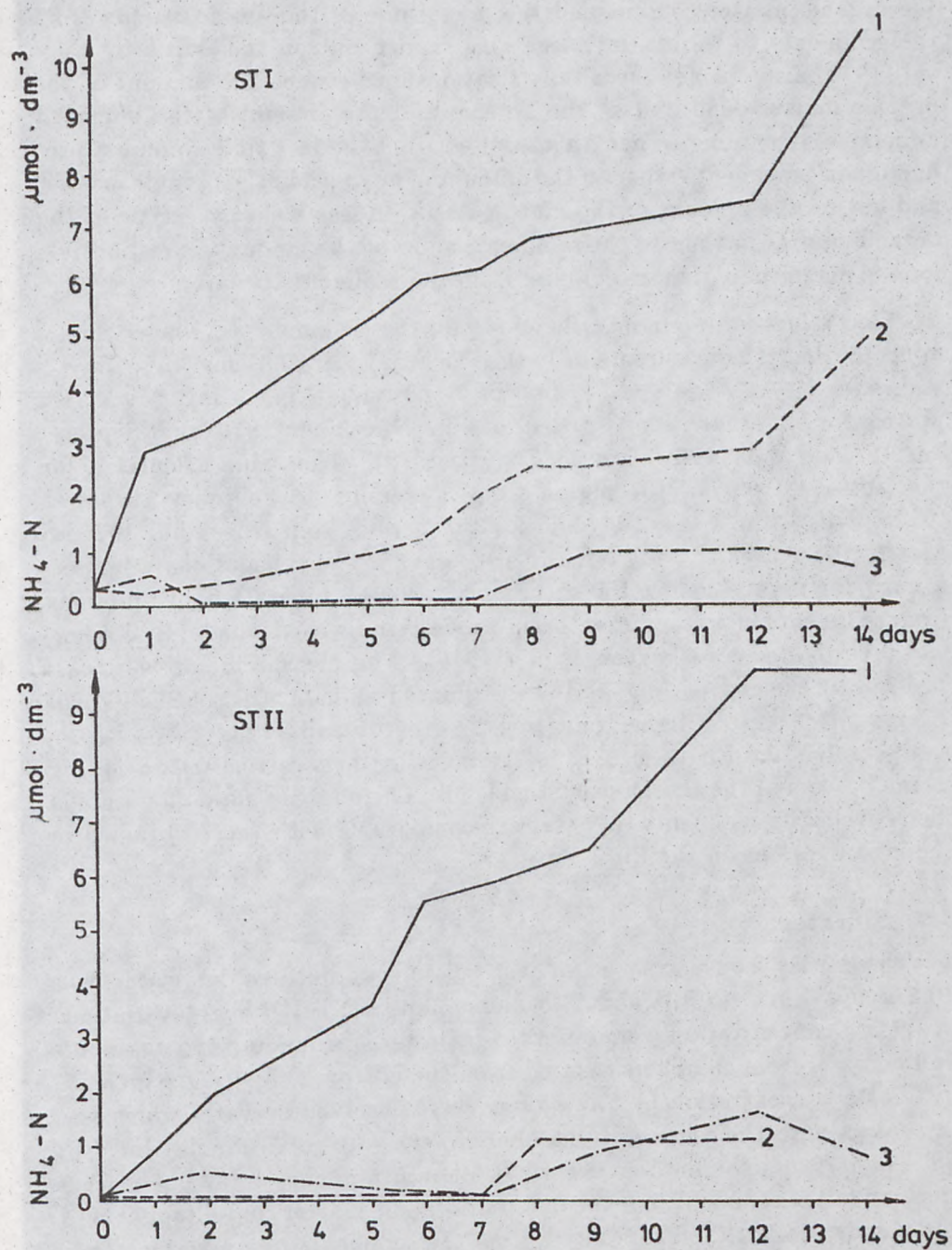

Fig. 8. Changes in ammonia concentration. 1, 2, 3 - as in Figure 4

matter. This means that no simple correlation has been observed between the organic matter content and the magnitude of the ammonia flux from the sediments to water. Investigations carried out on the Baltic by Engval (1978) also did not reveal any relationship between the amount of the organic matter deposited at the bottom and the amount of the liberated ammonia. According to her, this resulted from the fact that ammonia production is dependent rather on the amount of nitrogen in the organic matter, and not on the amount of the matter itself. It seems that the type of the organic matter passing to the sediment, and not the amount, is responsible for the magnitude of ammonia flux from the sediment to water.

The values of ammonia fluxes from the sediment to water determined during the measurements in the Puck Bay were $2.67 \text{ mg} \cdot \text{m}^{-2} \cdot \text{day}^{-1}$ and $4.06 \text{ mg} \cdot \text{m}^{-2} \cdot \text{day}^{-1}$. A flux of $5 \text{ mg NH}_4\text{-N m}^{-2} \cdot \text{day}^{-1}$ was reported for determinations carried out in November 1970 and September 1971 on the Swedish coast (Engval, 1978). The value calculated for the Gotland Deep for the period from September to February 1974 was $7.6 \text{ mg NH}_4\text{-N m}^{-2} \cdot \text{day}^{-1}$, while for the period from November 1975 to March 1976 it was $18.5 \text{ mg NH}_4\text{-N m}^{-2} \cdot \text{day}^{-1}$. The calculations were performed for depths below 150 m (Engval, 1978). Liberation of ammonia from sediments in a stagnating basin at western Swedish coast (Byfjorden) was investigated by Almgren *et al.* (1975). The measurements were carried out at the end of July, and the estimated ammonia nitrogen flux was $7.7 \text{ mg} \cdot \text{m}^{-2} \cdot \text{day}^{-1}$. Higher values of the flux (26 and $34 \text{ mg} \cdot \text{m}^{-2} \cdot \text{day}^{-1}$) were obtained by Engval (1978) in the investigations carried out in Spring at the bottom of the Baltic near Stockholm. The quoted values of ammonia fluxes from the sediments to water are comparable with those obtained in the investigations on the Puck Bay.

3.7. Silicates

The initial concentration of the dissolved silicates in water was $16.5 \mu\text{mole} \cdot \text{dm}^{-3}$ (ST I) and $11.5 \mu\text{mole} \cdot \text{dm}^{-3}$ (ST II). Slight variations of silicate concentration were observed in water surrounding the chambers and in water from chambers isolated from the bottom (Fig. 9). An increase in silicate concentration by a few times were observed in water which was in contact with the sediment (chamber No. 1) – up to $75 \mu\text{mole} \cdot \text{dm}^{-3}$ at ST I and $79 \mu\text{mole} \cdot \text{dm}^{-3}$ at ST II. It follows from this data that neither the kind of the sediment, nor the different organic matter content influenced the magnitude of the silicate fluxes from the sediments to sea water. They differed only slightly and were equal to $1.72 \text{ mmole} \cdot \text{m}^{-2} \cdot \text{day}^{-1}$ (at 12.5°C) and $2.1 \text{ mmole} \cdot \text{m}^{-2} \cdot \text{day}^{-1}$ (at 8.5°C). The obtained values are quite close to values obtained by Rozanov *et al.* (1988) in summer 1986 on the Black

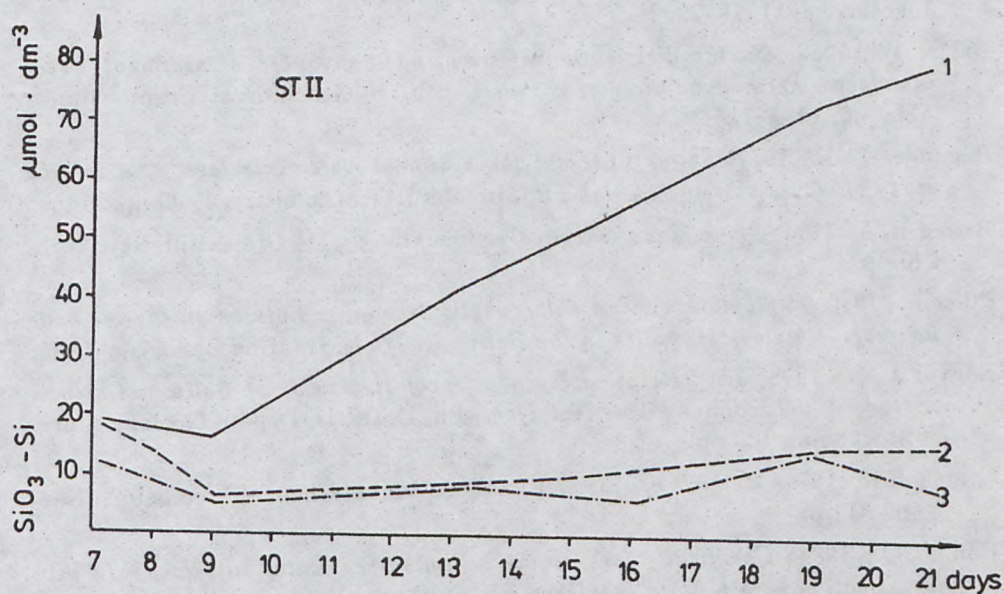
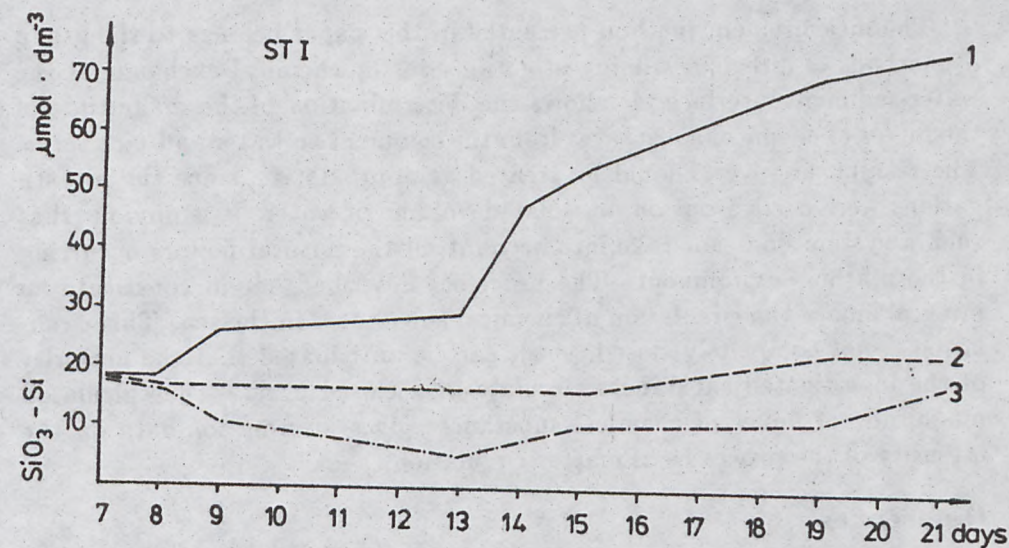

Fig. 9. Changes in silicate concentration. 1, 2, 3 - as in Figure 4

Sea ($1.72 \text{ mmole} \cdot \text{m}^{-2} \cdot \text{day}^{-1}$ at 19°C). The values for the Puck Bay are also close to those reported for Gullmarsfjorden by Rutgers van der Loeff *et al.* (1984).

4. Conclusions

The measurement method presented in this paper belongs to the group of methods of direct *in situ* investigations on the chemical exchange at the water-sediment interface. It allows the determination of the magnitude of the fluxes of chemical substances from the sediment to water and *vice versa*. The results, however, should be treated as approximate, since the investigations were carried out on an isolated volume of water. It is obvious that such a system does not take into account all the natural factors occurring in the marine environment. The processes described herein constitute an integral link of the circulation of chemical substances in the sea. This circulation is not completely closed, yet it can be anticipated that the majority of the investigated substances circulate in a closed cycle. The calculated magnitude of fluxes of chemical substances gives information-data on the intensity of the processes of matter circulation.

References

- Almgren T., Danielsson L. G., Dyrssen L. D., Johansson T., Nygvist G., 1975, *Release of inorganic matter from sediments in a stagnat basin, Thalassia Jugoslavica*, 11, 19-29.
- Balzer W., 1982, *On the distribution of iron and manganese at sediment/water interface: thermodynamic versus cinetic control*, *Geochim. et Cosmochimica Acta*, 46, 1153-1161.
- Bågander L. E., 1977, *Sulfur fluxes at the sediment-water interface - an in situ study of closed system, Eh and pH*, *Microbiol. Geochemistry*, 1, 90 pp.
- Berner R. A., 1971, *Principles of chemical sedimentology*, Mc Graw-Hill, New York, 240 pp.
- Edler R., 1979, *Phytoplankton and chlorophyll. Recommendations on the methods for marine biological studies in the Baltic Sea*, *Baltic Marine Biologists*, 5-38.
- Engval A. G., 1978, *The fate of nitrogen in early diagenesis of Baltic sediments. A study of the sediment-water interface*, Ph. D. thesis, Dep. of Geology, Univ. of Stockholm, 103 pp.
- Grasshoff K., 1976, *Methods of seawater analysis*, Verlag Chemie, Weinheim - New York, 317 pp.
- Hall P. O., 1984, *Chemical fluxes at the sediment-sea water interface: In situ investigation with benthic chambers*, Ph. D. thesis, Univ. Goteborg.
- Holm N. G., 1978, *Phosphorus exchange through the sediment-water interface. Mechanism studies of dynamic processes in the Baltic Sea*, Ph. D. thesis., Univ. of Stockholm, 149 pp.
- Jankowska H., Bolalek J., 1990, *Jon chlorkowy w wodach porowych osadów dennych (Chloride ion in the interstitial water of bottom sediments from the Puck Bay)*, *Przegl. Geolog.*, 6, 253-258, (in Polish).

- Kester J. R., Pytkiewicz R. M., 1967, *Determination of the apparent dissociation constants of phosphorus acid in seawater*, *Limnol. Oceanogr.*, 12, 243-252.
- Lerman A., 1978, *Chemical exchange across sediment-water interface*, *Ann. Rev. Earth Planet.*, 6, 1, 291-301.
- Pieczka F., 1973, *Metodyka badań osadów czwartorzędowych (Methodology of quaternary sediments examination)*, Rühle E. (Ed.), *Wyd. Geolog.*, Warszawa, 466 p. (in Polish).
- Rožanov A. G., Stayanov A. S., Vershinin, 1988, *On procedure of direct measurements of chemical exchange at the boundary between near-bottom nature and sea-bed*, *Okeanologiya*, XXVII, 680-685, (in Russian).
- Rutgers van der Loeff M. M., Anderson L. G., Hall P. O., Iverfeld A., Josefoon A. B., Sundby B., Wester S. F. G., 1984, *The asphyziation technique: An approach to distinguishing between molecular diffusion and biologically mediated transport at the sediment-water interface*, *Limnol. Oceanogr.*, 29, 675-686.
- Sayles F. Z., 1979, *The composition and diagenesis of interstitial solution. 1. Fluxes across the Atlantic ocean*, *Geochim. et Cosmochimica Acta*, 43, 527-545.
- Shishkina O. V., 1972, *Geokhimiya morskikh i okeanicheskikh ilovykh vod*, Nauka, Moskva, 228 pp.
- Valderrama J. C., 1981, *The simultaneous analysis of total nitrogen and phosphorus in natural water*, *Mar. Chem.*, 10, 109-122.
- Wentworth C. K., 1922, *A scale of grade and class terms for clastic sediments*, *J. Geol.*, 30, 377-392.